

Capítulo 37 (Turn) Turno

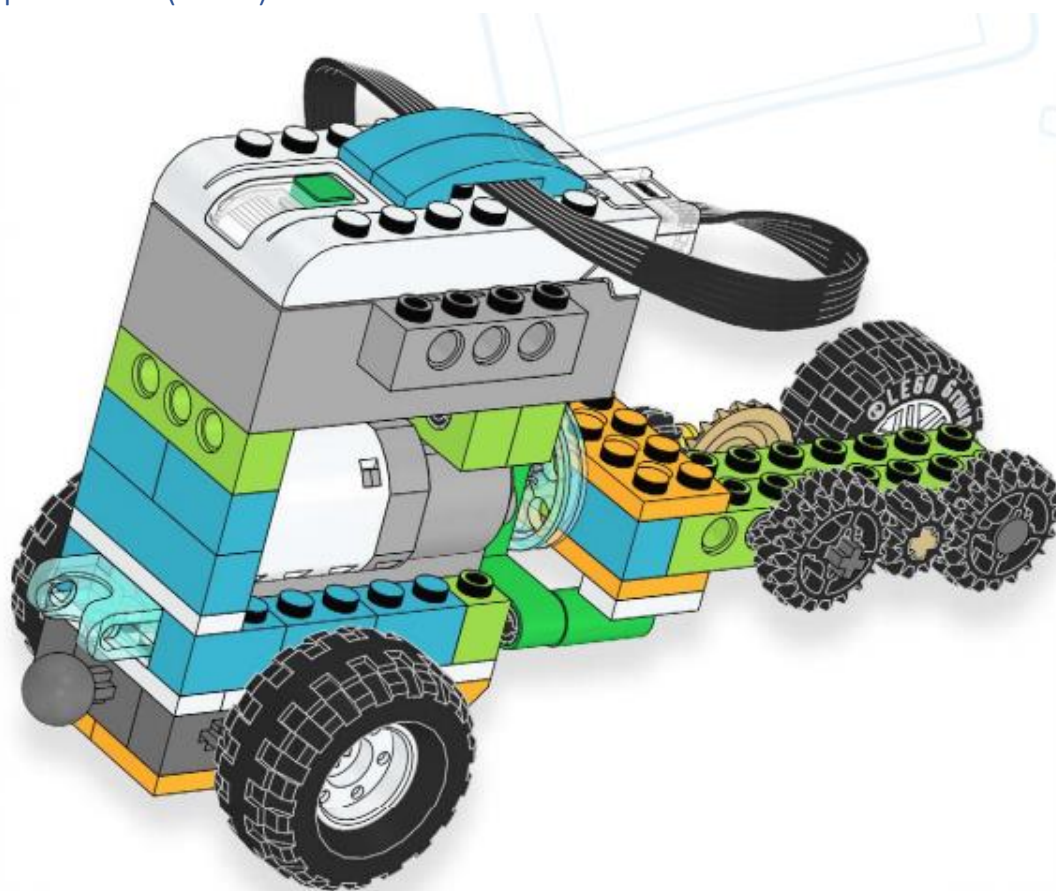

Para realizar este capítulo necesitaremos un solo Kit.

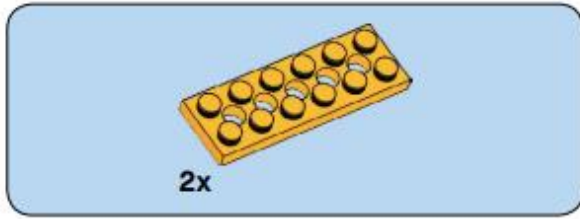

1

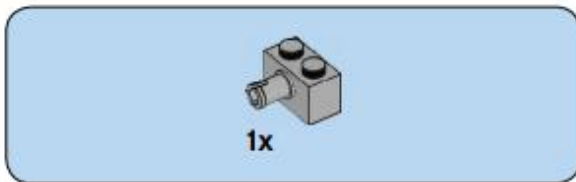
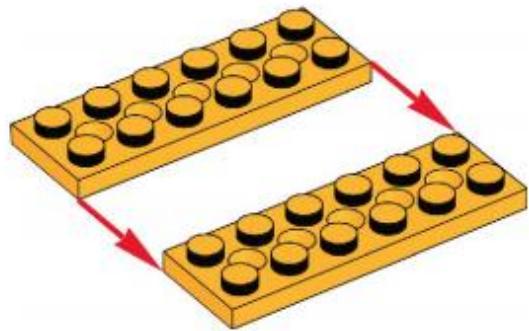

2

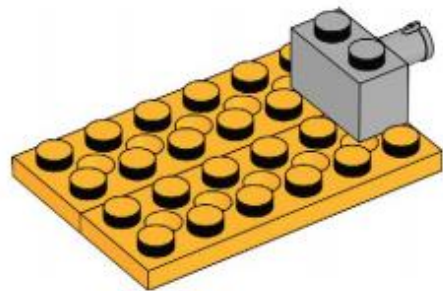

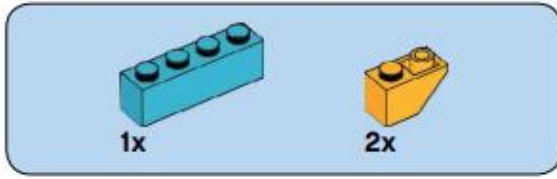

3

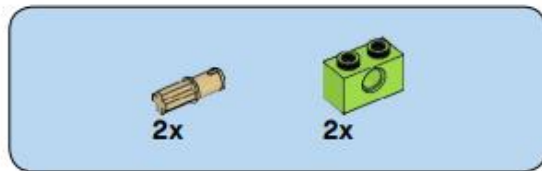
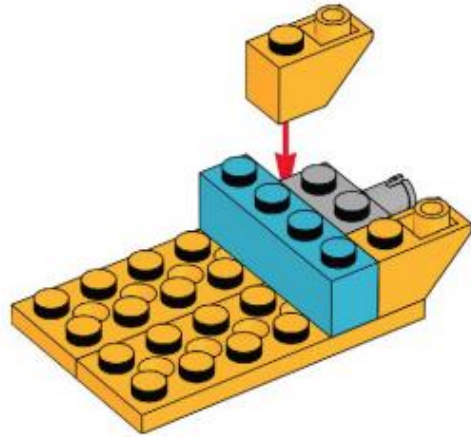

4

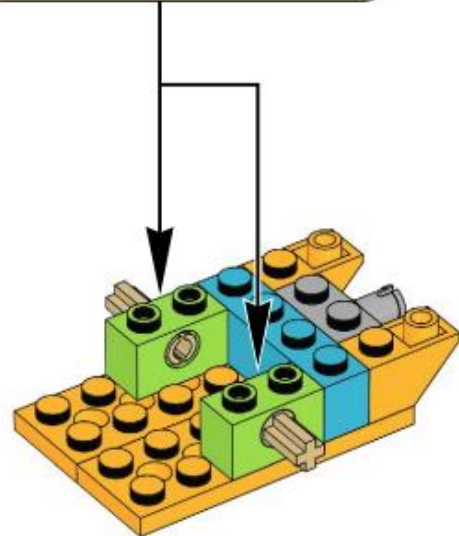
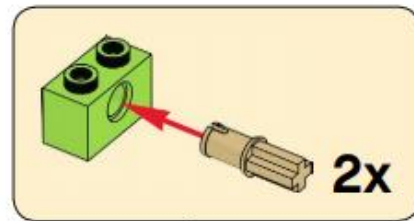

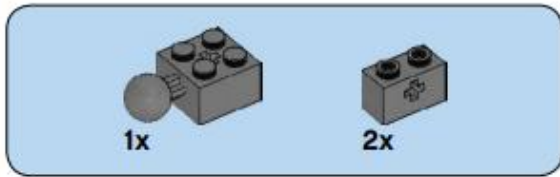

5

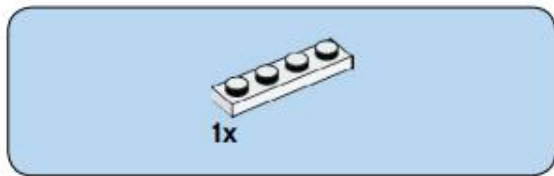
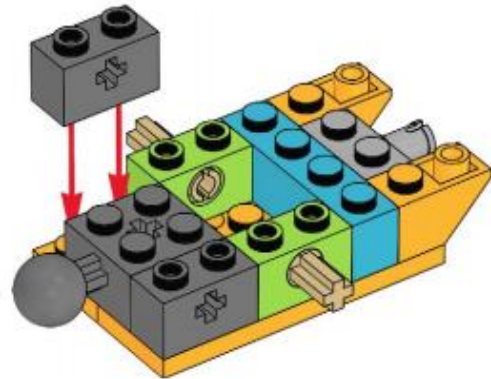

6

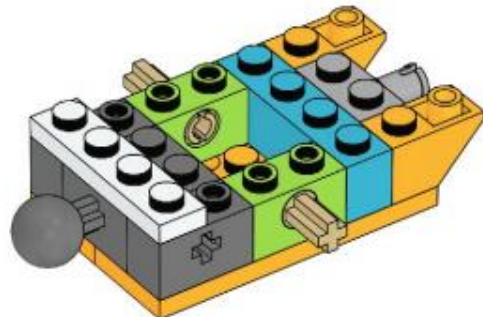

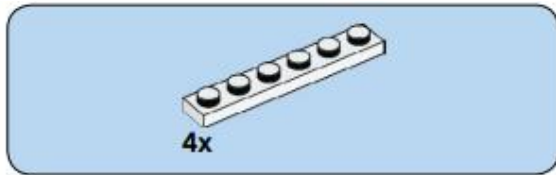

7

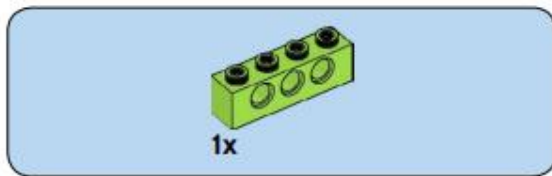
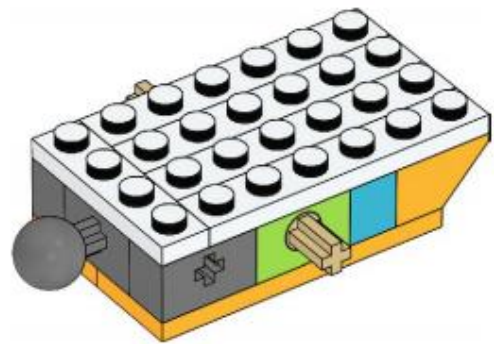

8

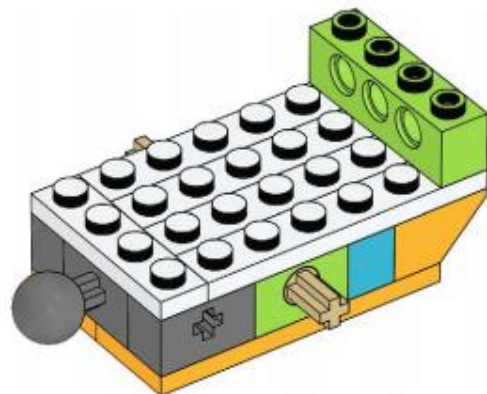

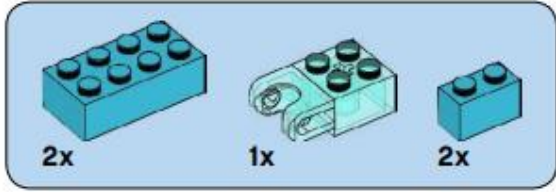

9

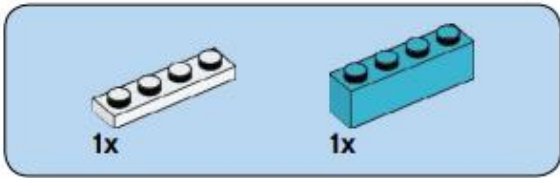
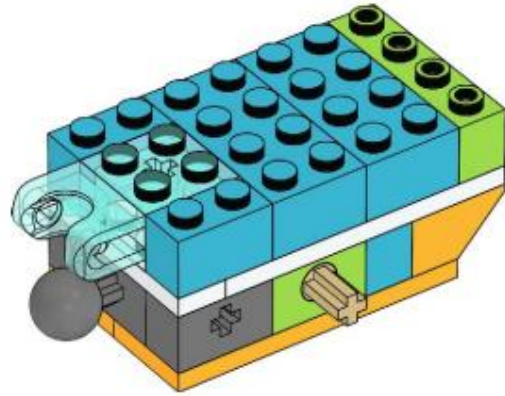

10

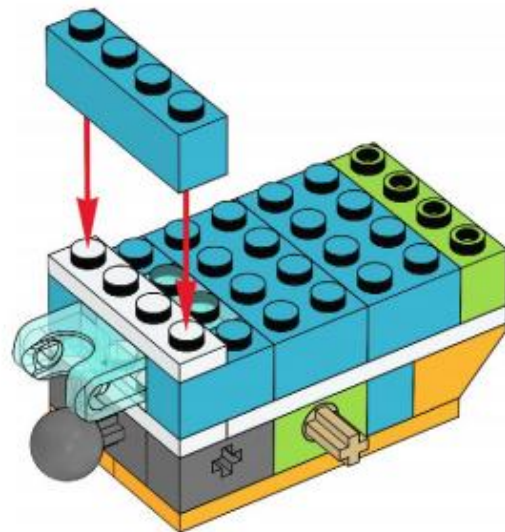

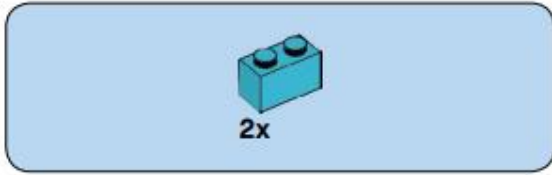

11

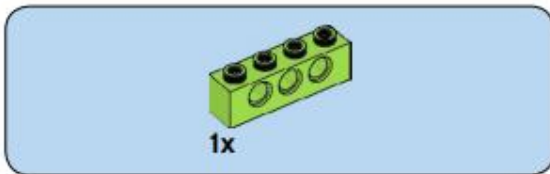
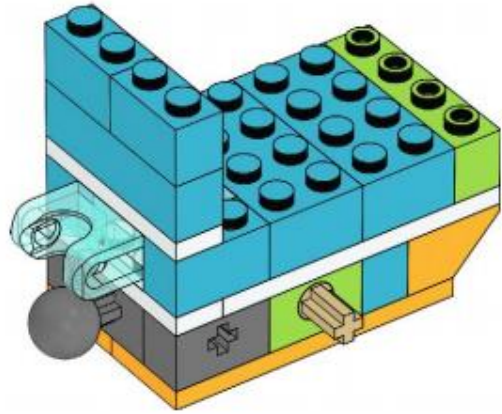

12

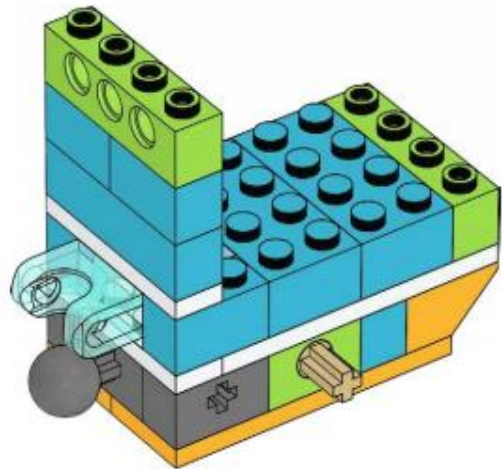

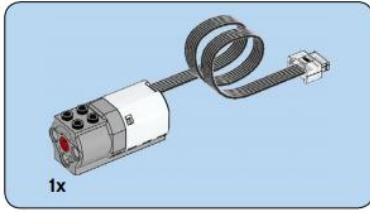

13

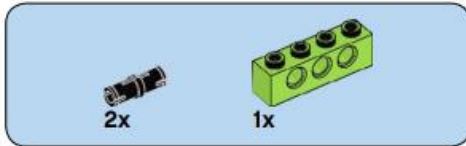
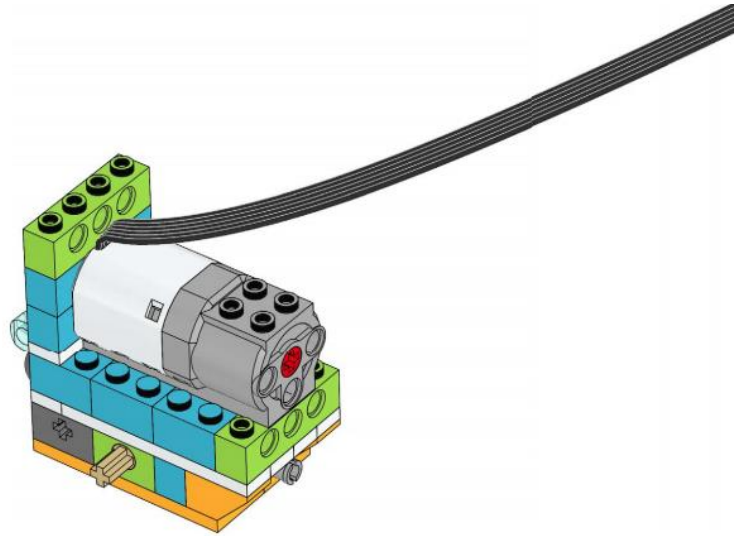

14

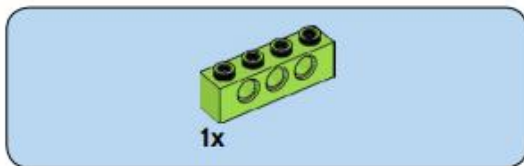

15



16

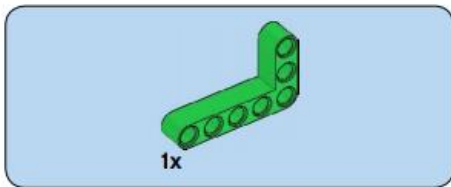
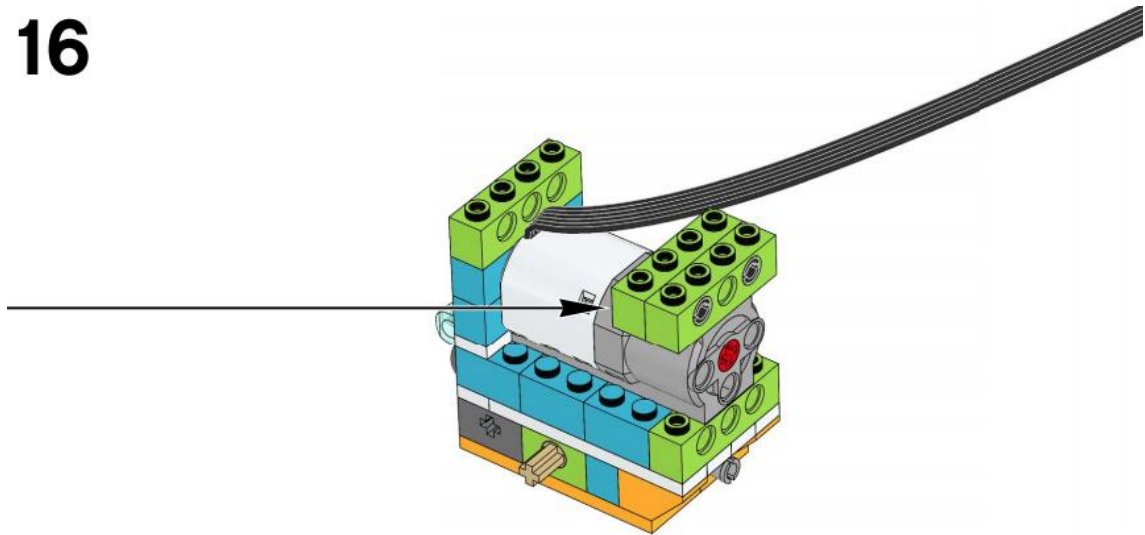

17

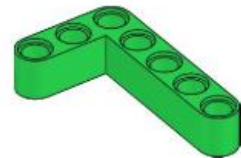

18

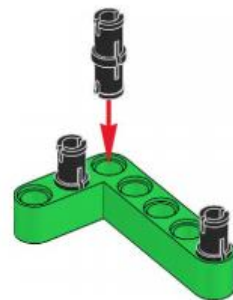

19

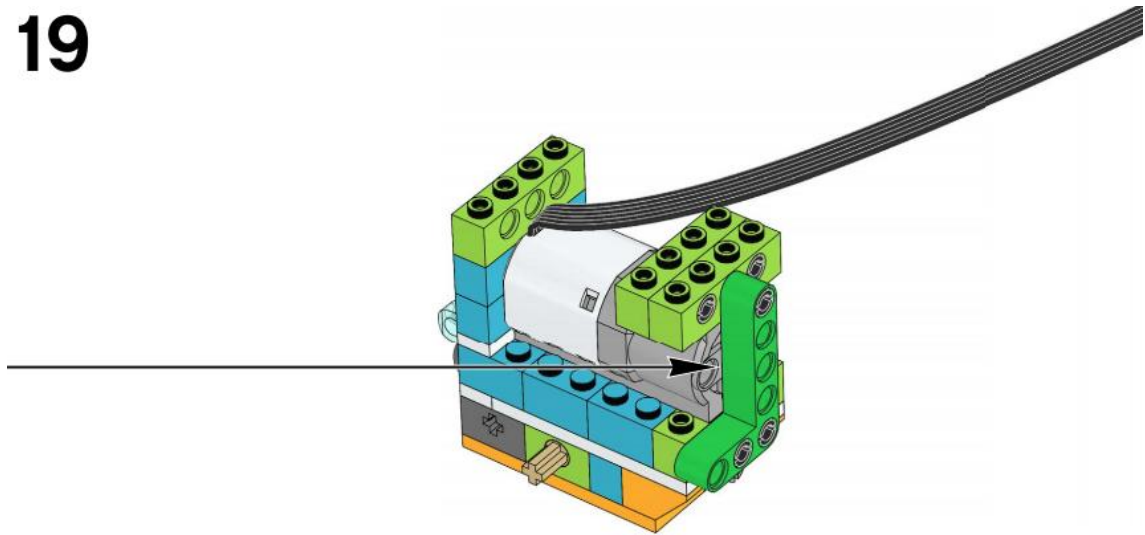

20

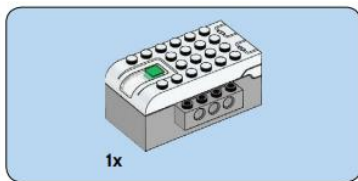
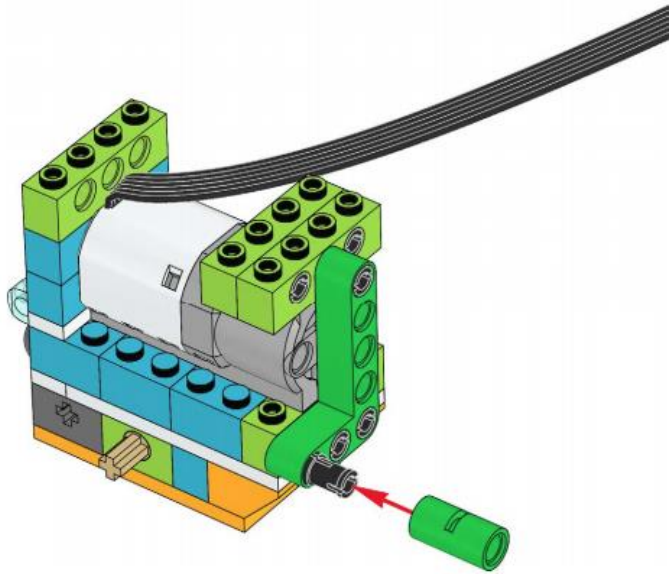

21

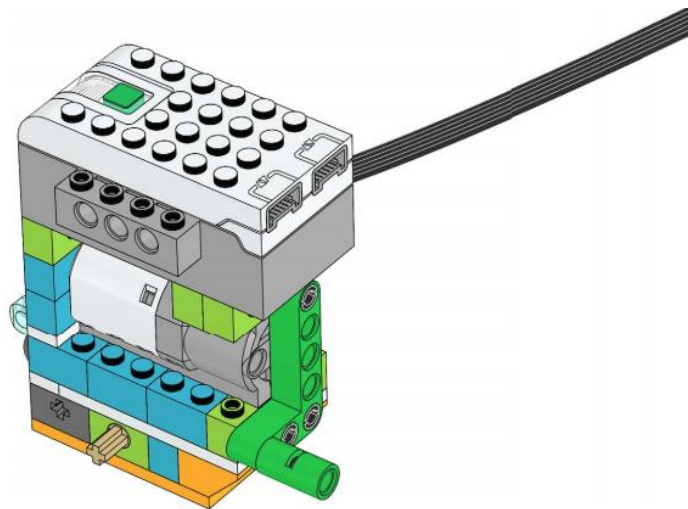

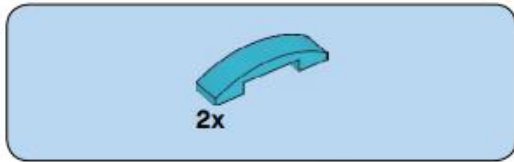

22

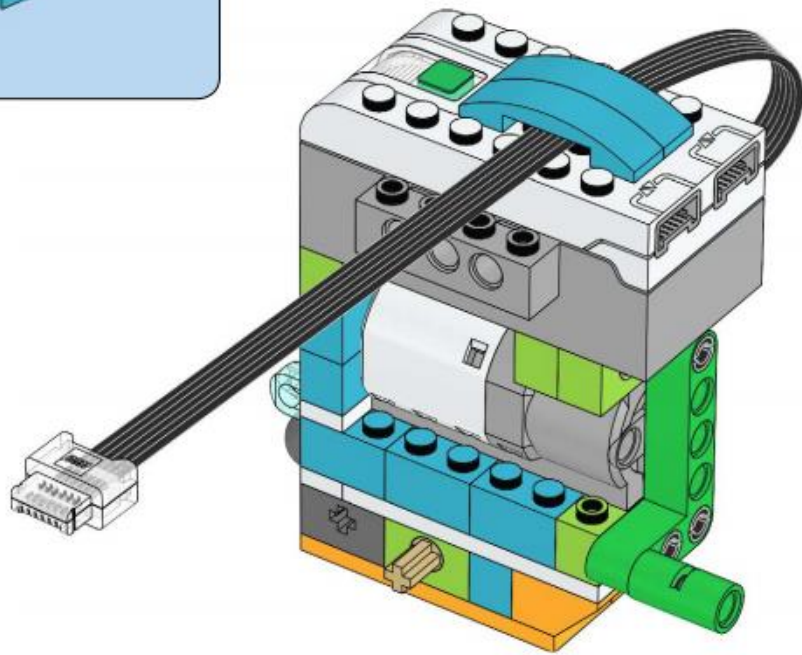

23

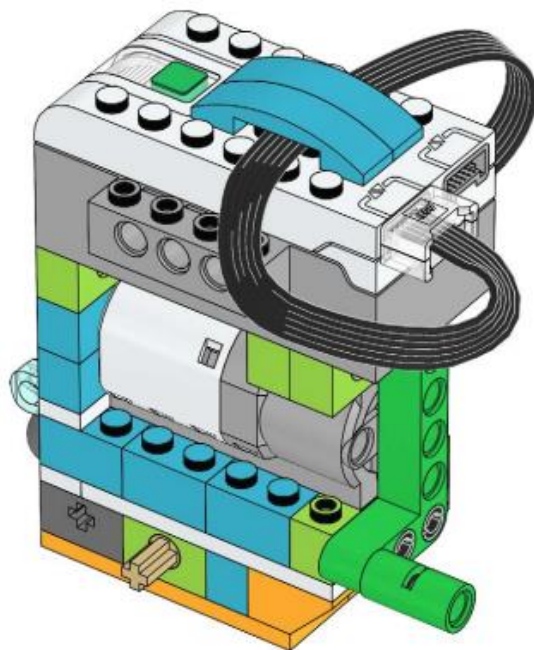

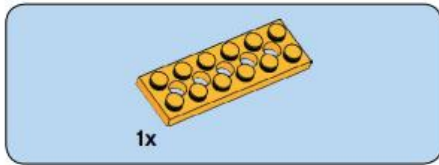

24

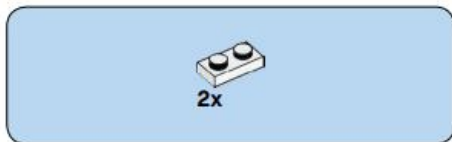
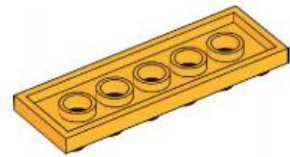

25

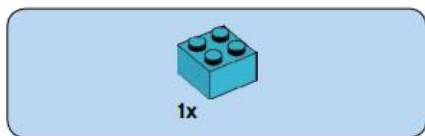
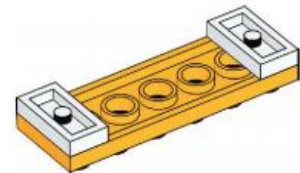

26

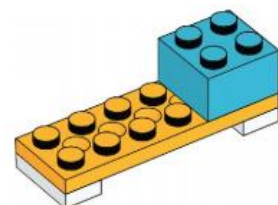

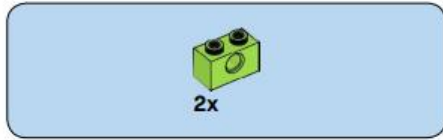

27

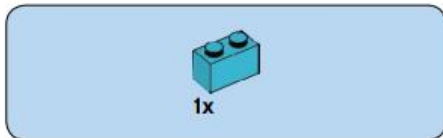
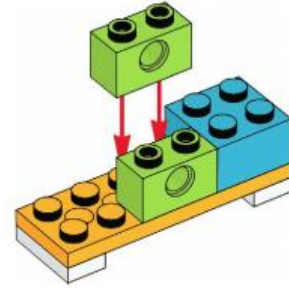

28

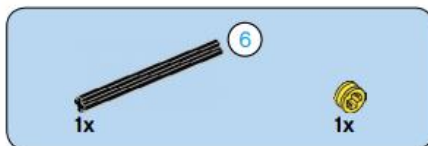
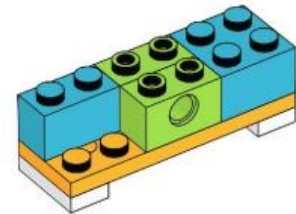

29



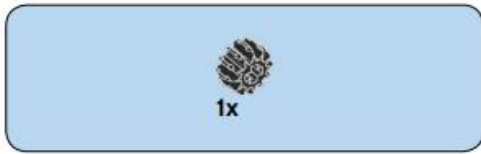

30



31

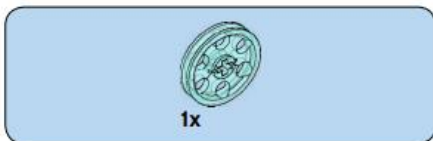

32

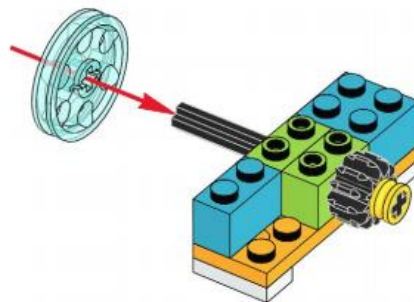

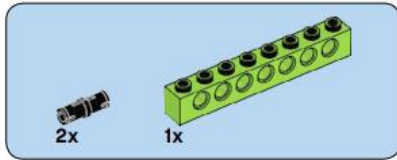

33

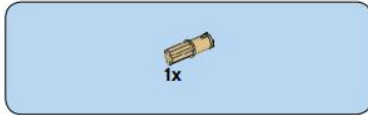

34

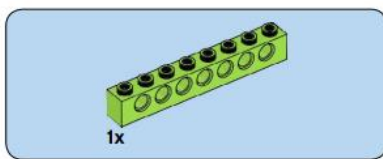
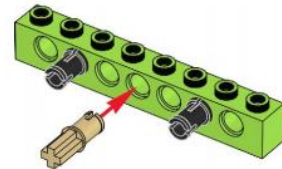

35



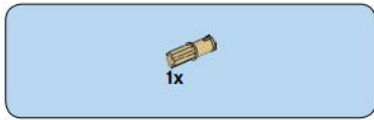

36

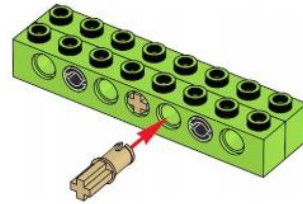

37

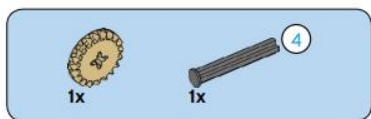
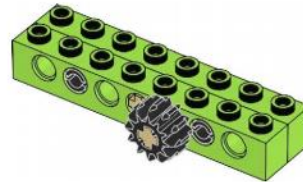

38

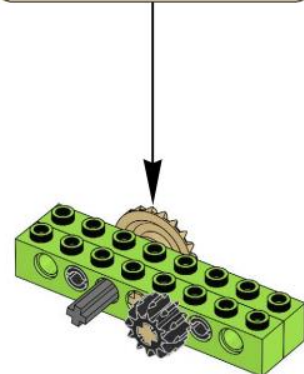
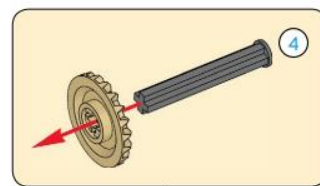

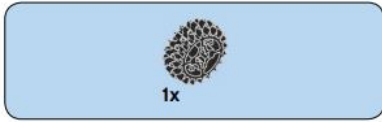

39

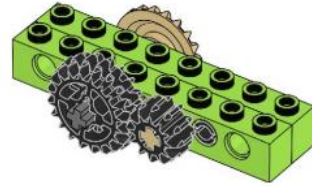

40

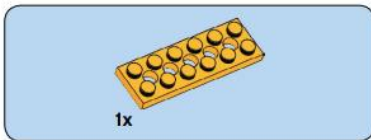
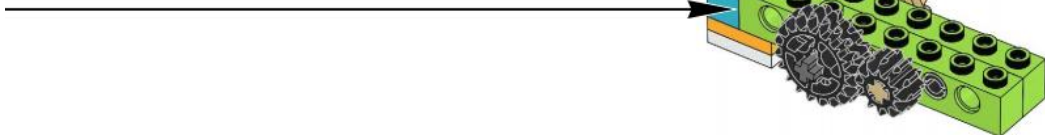

41

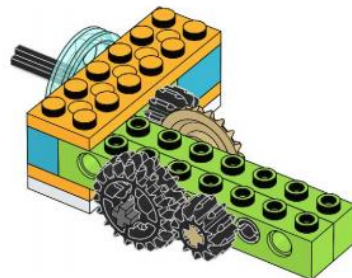

42

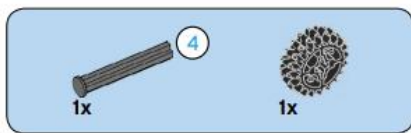
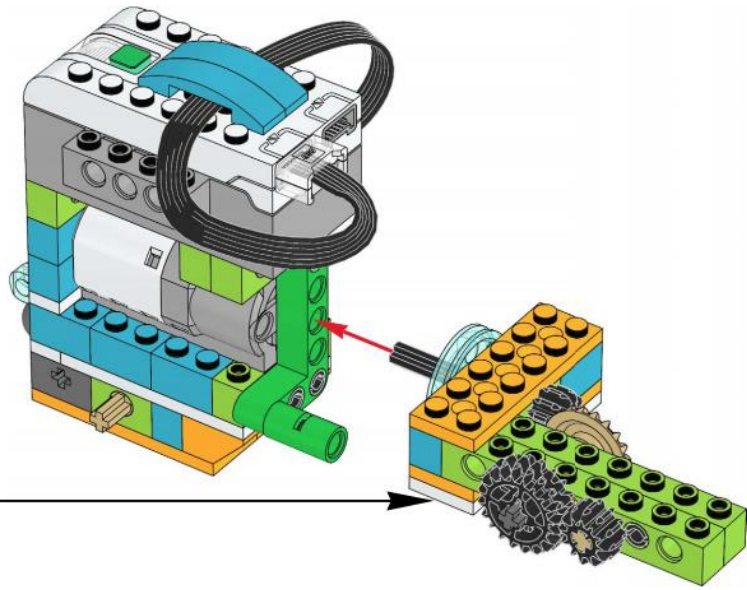

43

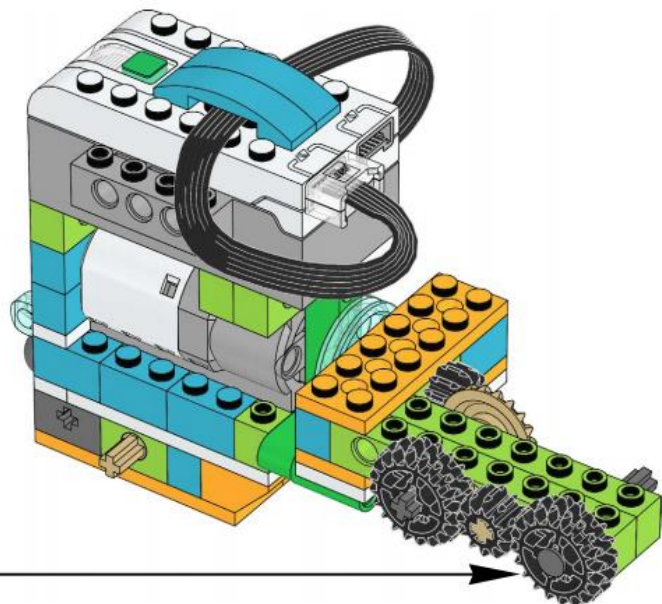
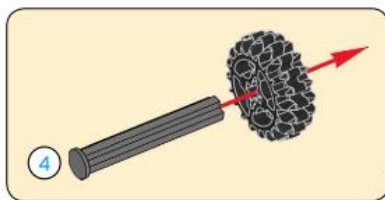

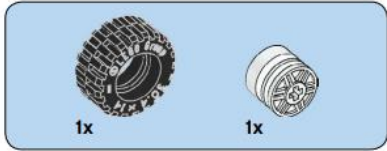

44

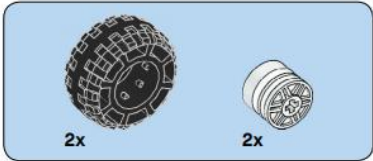
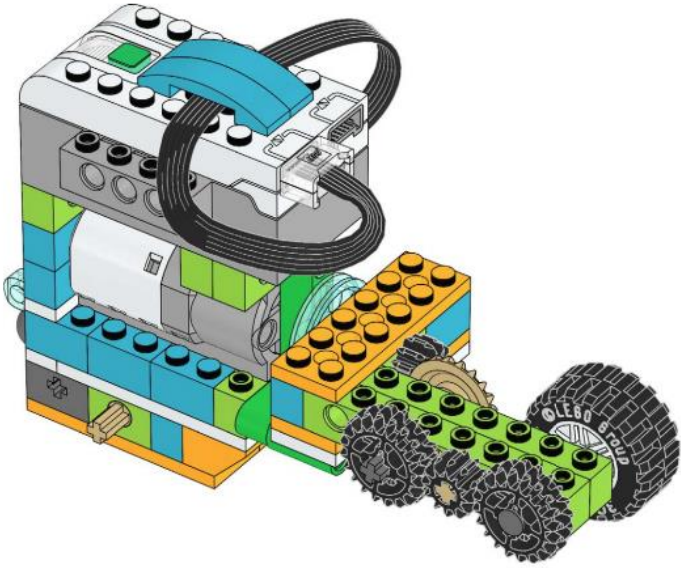

45

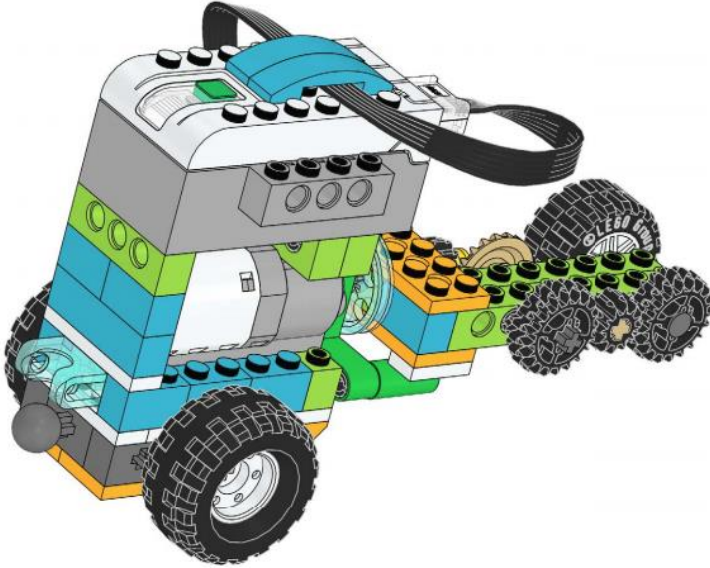

Codificación

